

SS-43D31

Optional knob type

TA	GE	GD	MX	AT	NY

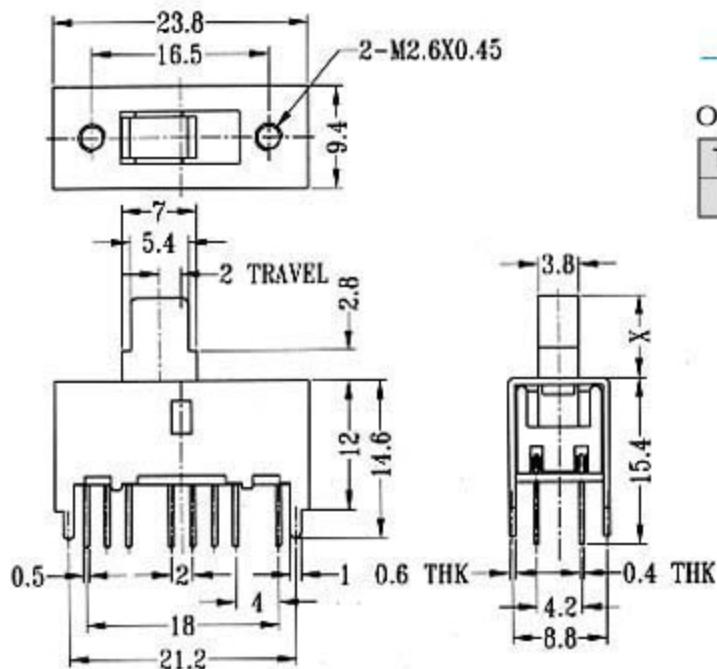

CIRCUIT DIAGRAM

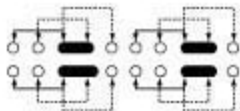

SPECIFICATIONS

Rating: 0.3A 50V DC
Function: 4P3T