

SS-42H01

Optional knob type

MX	GD	AT	NY		

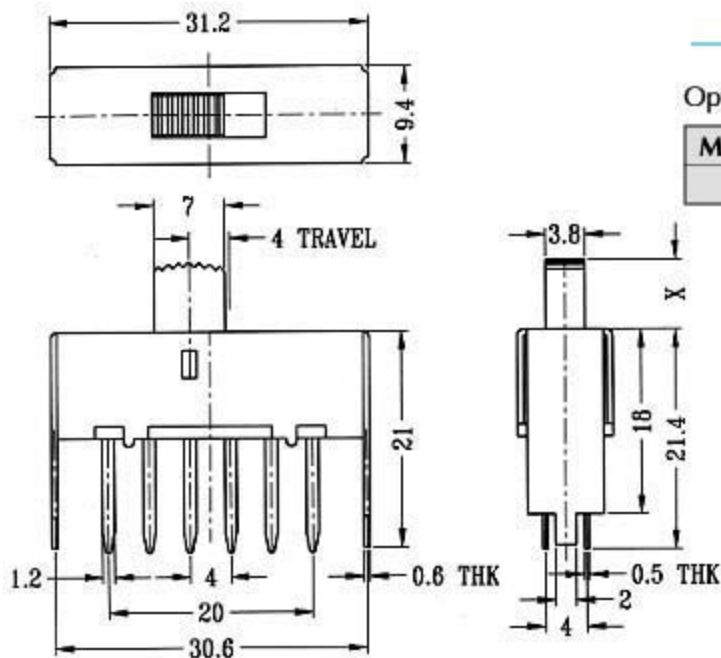

CIRCUIT DIAGRAM

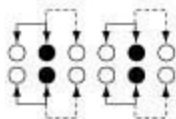

SPECIFICATIONS

Rating: 0.3A 50V DC

Function: 4P2T