

SS-42D25

Optional knob type

GE	VA				

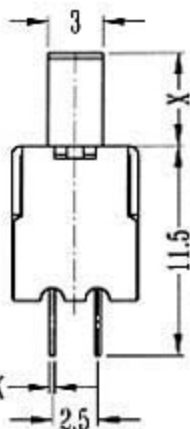
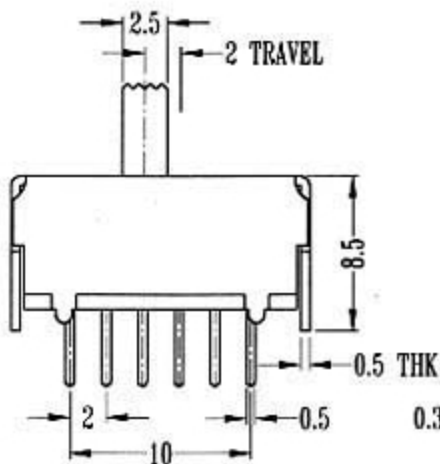
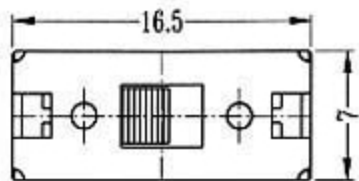

CIRCUIT DIAGRAM

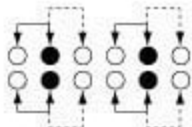

SPECIFICATIONS

Rating: 0.3 A 50V DC

Function: 4P2T