

SS-24H02

Optional knob type

MX	AT	NY	GD		

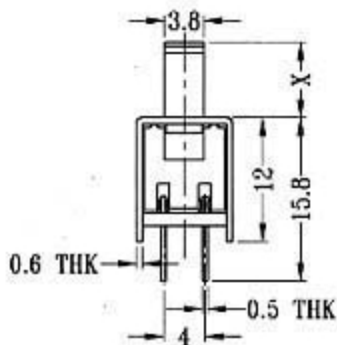
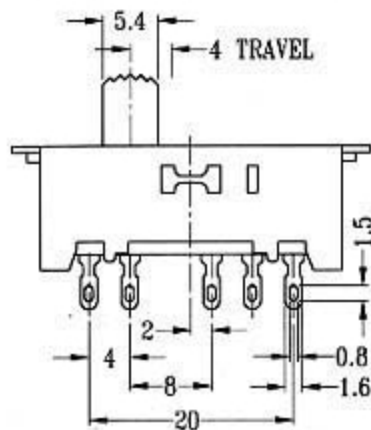
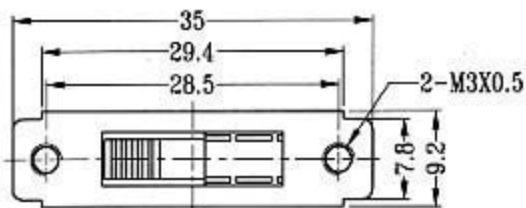

CIRCUIT DIAGRAM

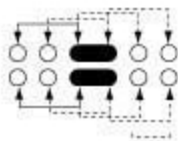

SPECIFICATIONS

Rating: 0.3A 50V DC

Function: 2P4T