

SS-23F02

Optional knob type

MX	TA	GD	NY	AT	GE

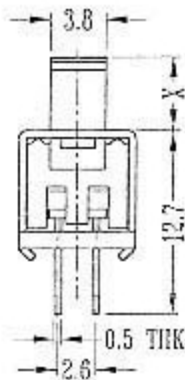
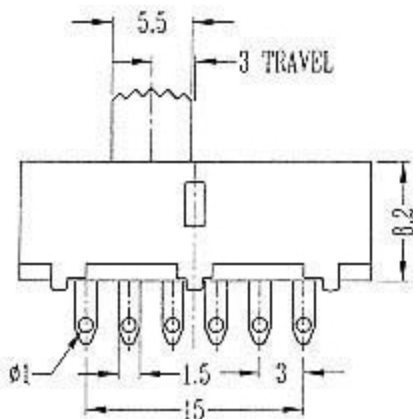
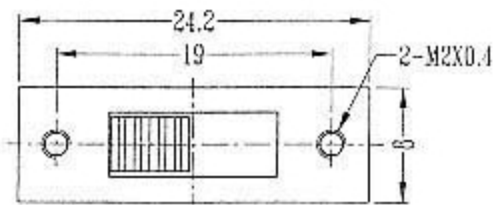

CIRCUIT DIAGRAM

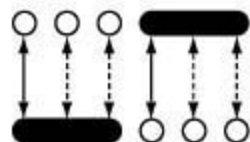

SPECIFICATIONS

Rating:0.5A 50V DC

Function:2P3T