

SS-23E29

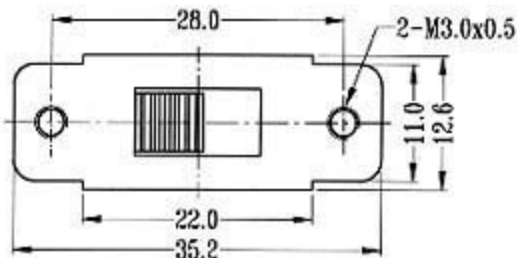

Optional knob type

GD	TA	UB			

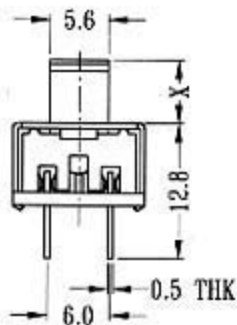
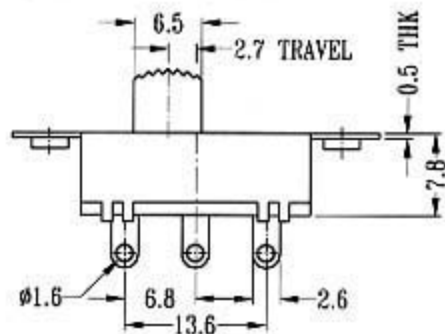

CIRCUIT DIAGRAM

SPECIFICATIONS

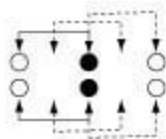

Rating:1.5A 250V AC

Function:2P3T