

SS-23E26

Optional knob type

GD	TA	UB			

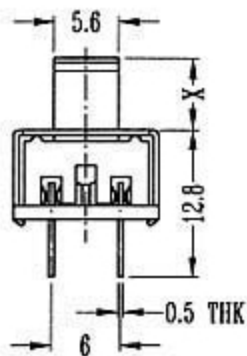
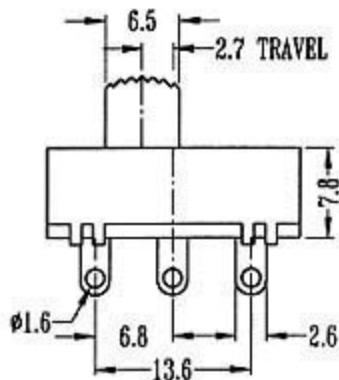
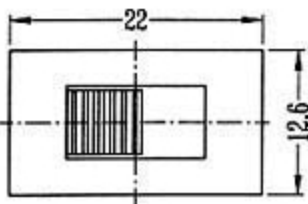

CIRCUIT DIAGRAM

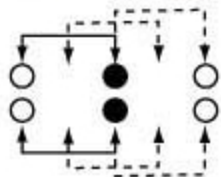

SPECIFICATIONS

Rating: 1.5A 250V AC

Function: 2P3T