

SS-23E10

Optional knob type

GD	TA	UB			

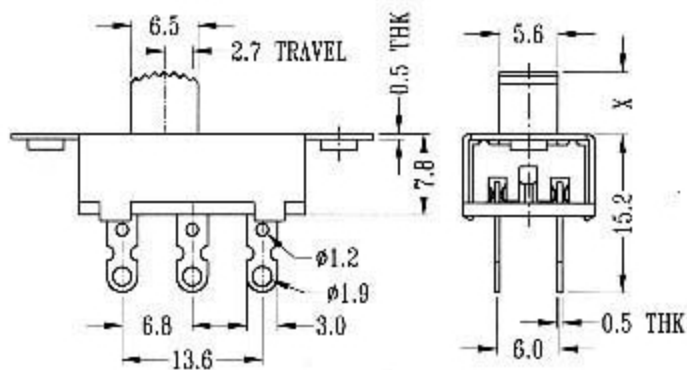
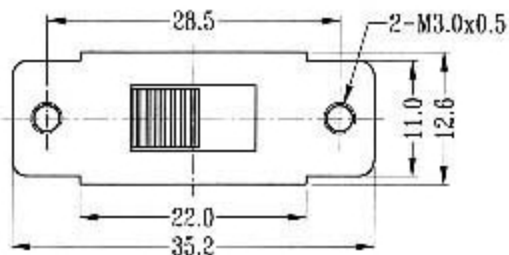

CIRCUIT DIAGRAM

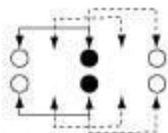

SPECIFICATIONS

Rating: 1.5A 250V AC

Function: 2P3T