

SS-23E02

Optional knob type

GE				

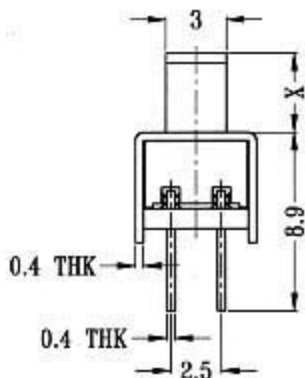
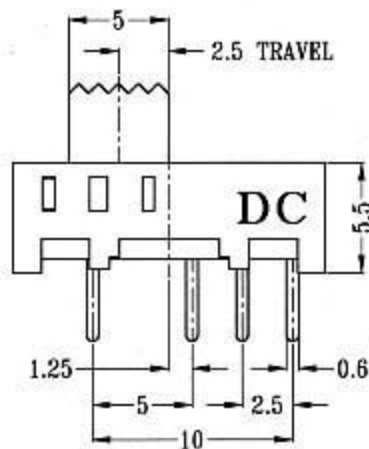
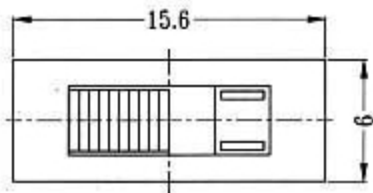

CIRCUIT DIAGRAM

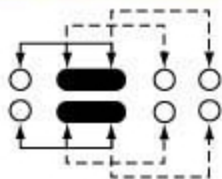

SPECIFICATIONS

Rating:0.3A 50V DC

Function:2P3T