

SS-12F25

Optional knob type

GA	GE	GD	TA	AT	NT
MX					

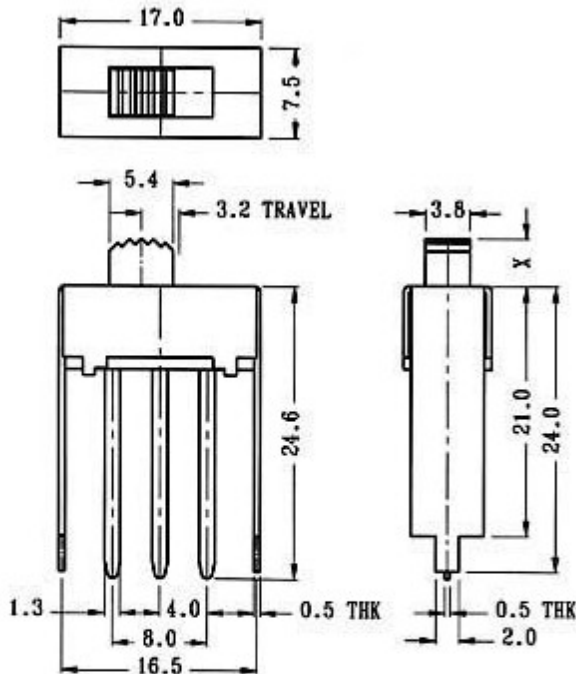

CIRCUIT DIAGRAM

SPECIFICATIONS

N NON-SHORTING



Rating : 0.5A 50V DC

Function: 1P2T