

# SS-12F18

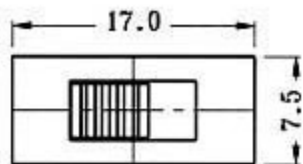

Optional knob type

GA	GE	GD	TA	AT	NT
MX					

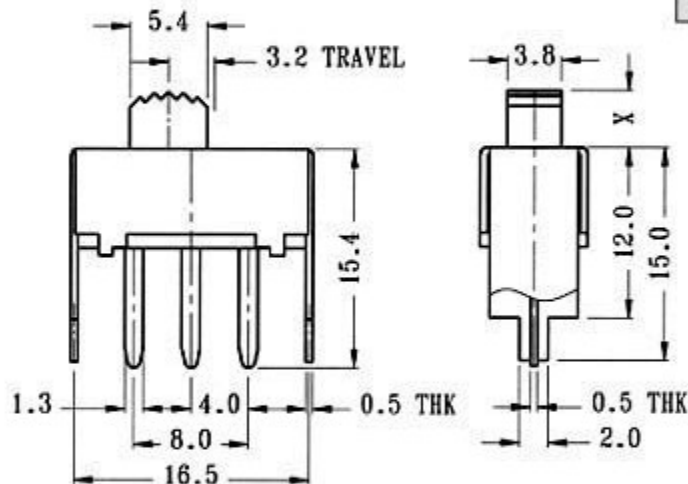

**CIRCUIT DIAGRAM**

**SPECIFICATIONS**

**N** NON-SHORTING



Rating : 0.5A 50V DC

Function: 1P2T