

SS-12F07

Optional knob type

GA	GE	GD	TA	AT	NT
MX					

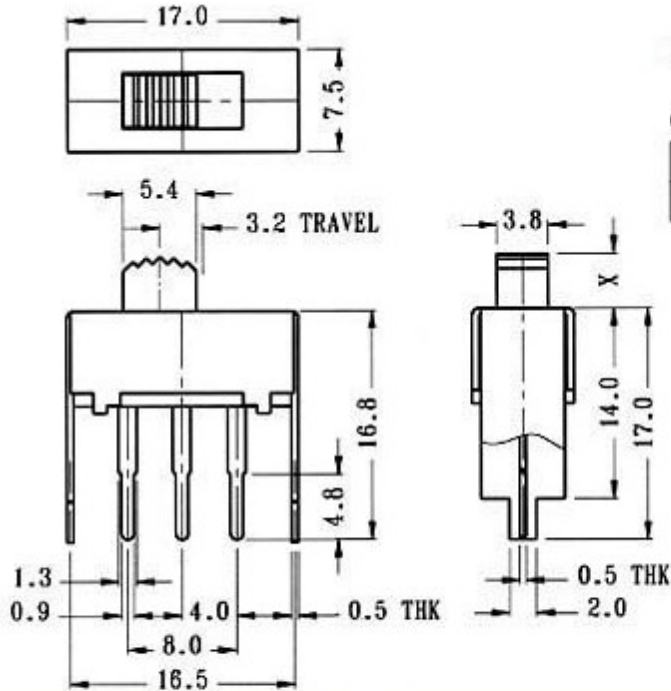

CIRCUIT DIAGRAM

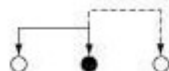

SPECIFICATIONS

Rating : 0.5A 50V DC
Function: 1P2T

N NON-SHORTING