

SS-12D02

Optional knob type

VA	TA	GE			

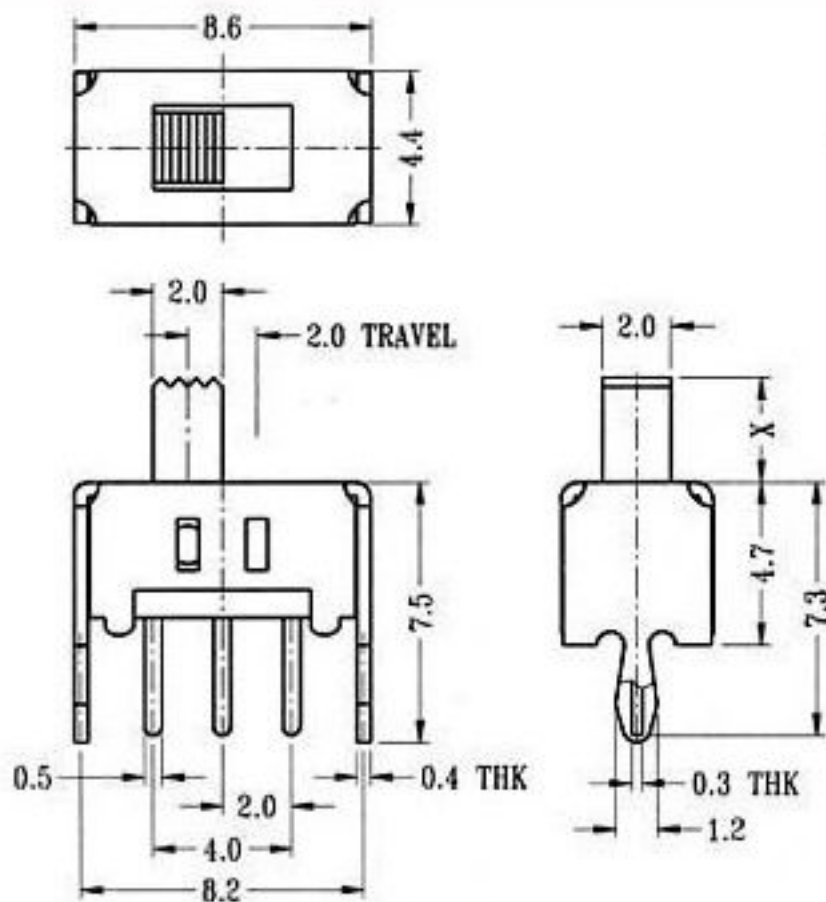

CIRCUIT DIAGRAM



SPECIFICATIONS

Rating : 0.3A 50V DC
Function: 1P2T

N NON-SHORTING