

SS-12D01

Optional knob type

TB					

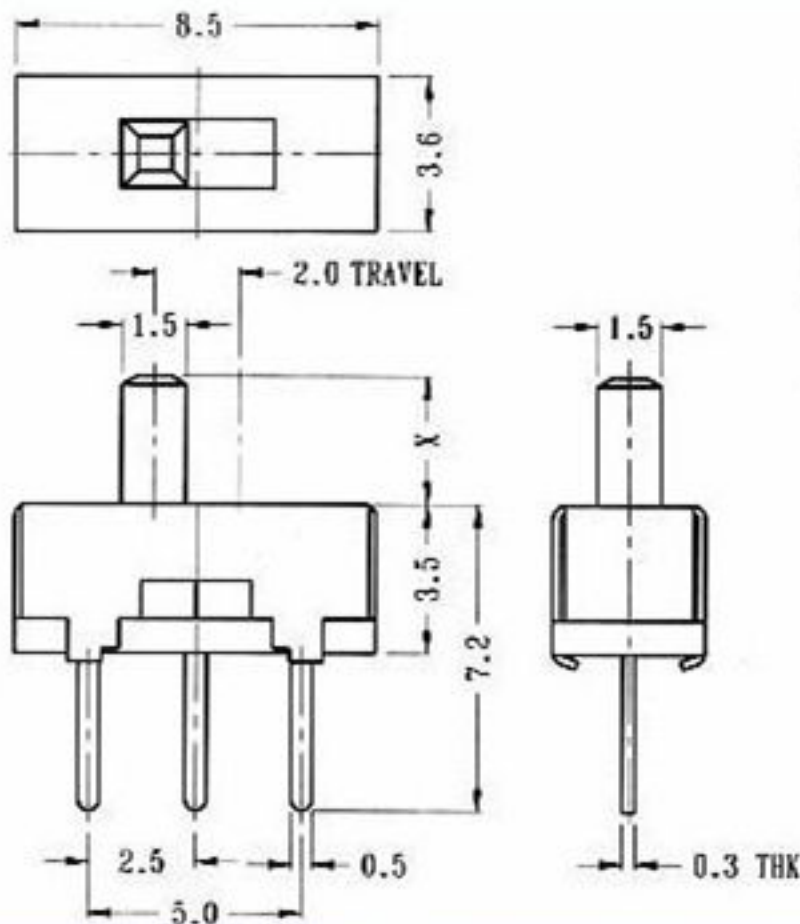

CIRCUIT DIAGRAM



SPECIFICATIONS

Rating : 0.3A 50V DC
Function: 1P2T

NON-SHORTING