

SS-11G07

GX				

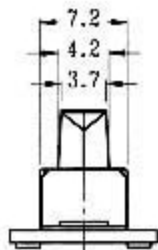

CIRCUIT DIAGRAM

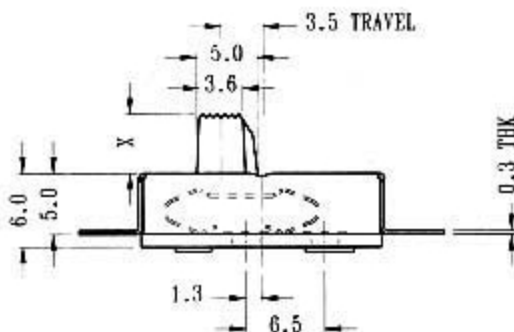
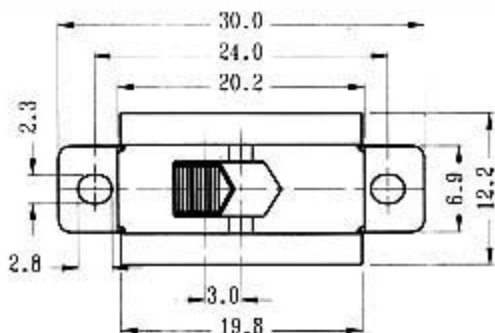

SPECIFICATIONS

Rating : 0.5A 12V DC
Function: 1P1T