

SS-11G04

Optional knob type

GX				

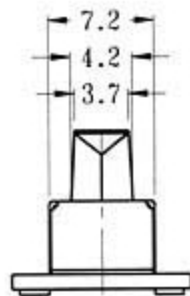
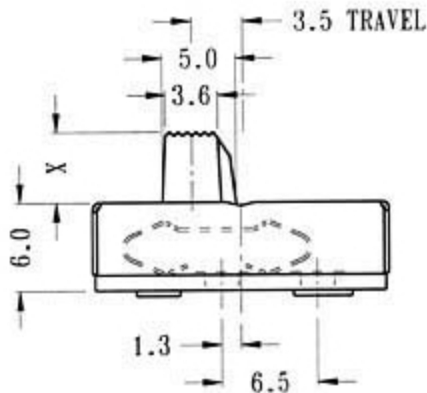
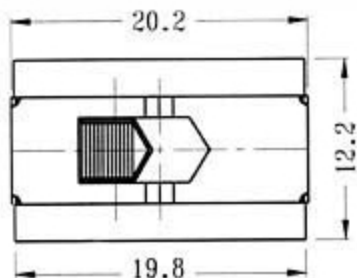

CIRCUIT DIAGRAM

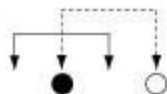

SPECIFICATIONS

Rating : 0.5A 12V DC

Function: 1P1T