

# SK-22H13

Optional knob type

GE				

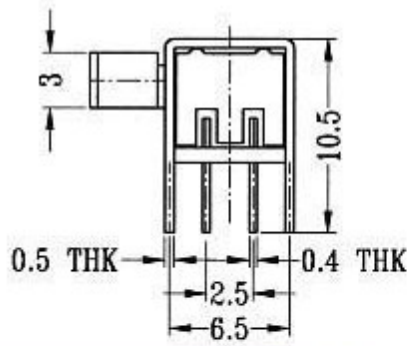
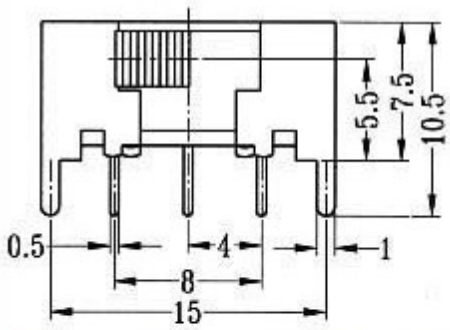
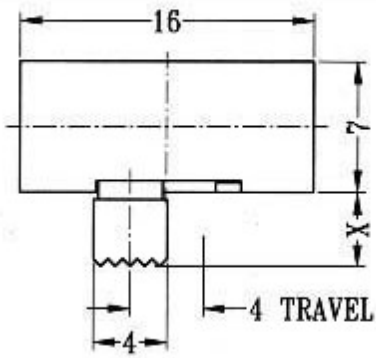

## CIRCUIT DIAGRAM

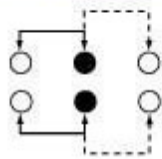

## SPECIFICATIONS

Rating : 0.3A 50V DC  
Function : 2P2T

**N** NON-SHORTING