

RC-434

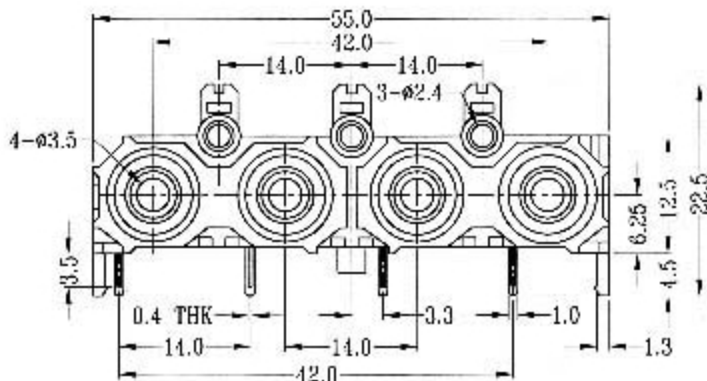

CIRCUIT DIAGRAM

SPECIFICATIONS

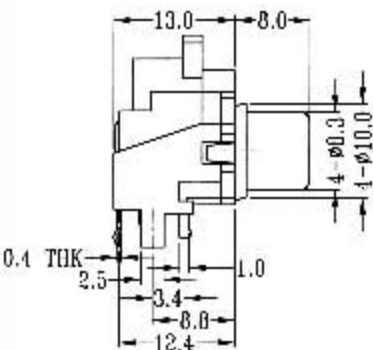
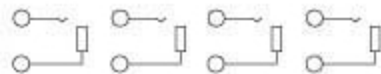

Rating : 0.3A 30V DC