

RC-325

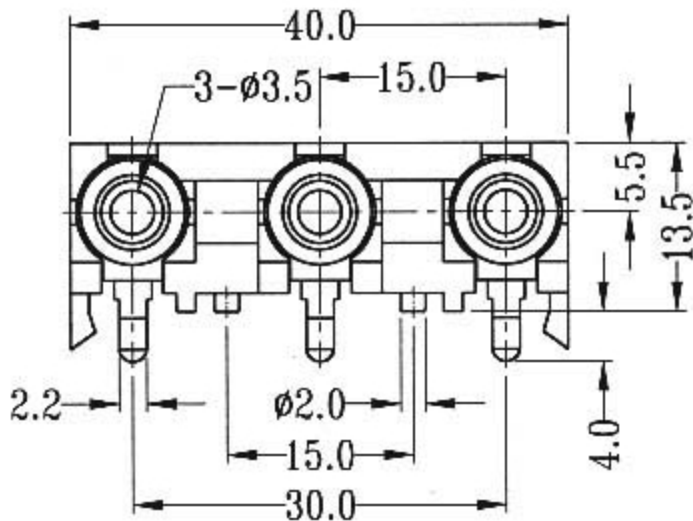

CIRCUIT DIAGRAM

SPECIFICATIONS

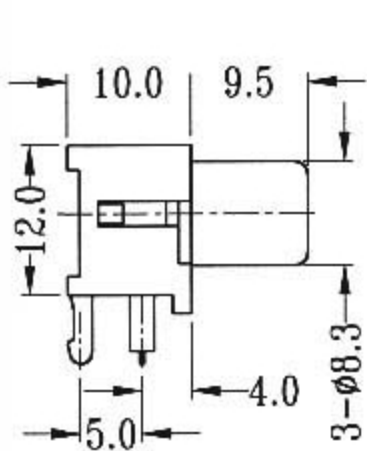

Rating : 0.3A 30V DC