

RC-141

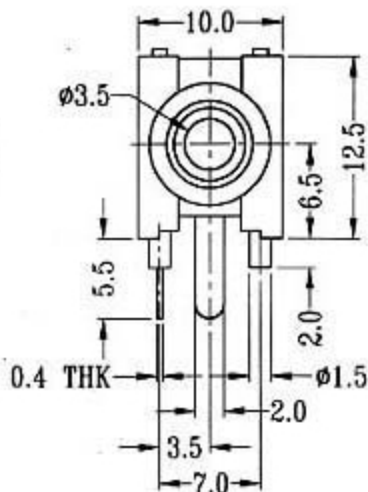

CIRCUIT DIAGRAM

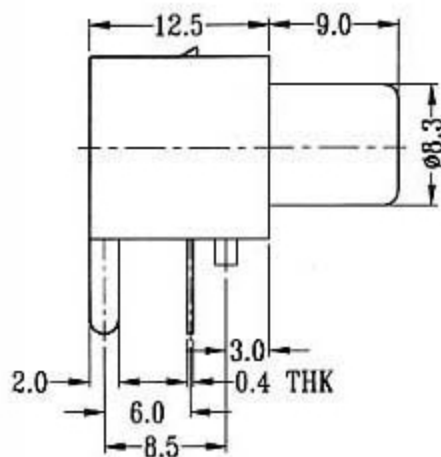
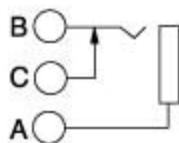

SPECIFICATIONS

Rating : 0.3A 30V DC