

RC-125

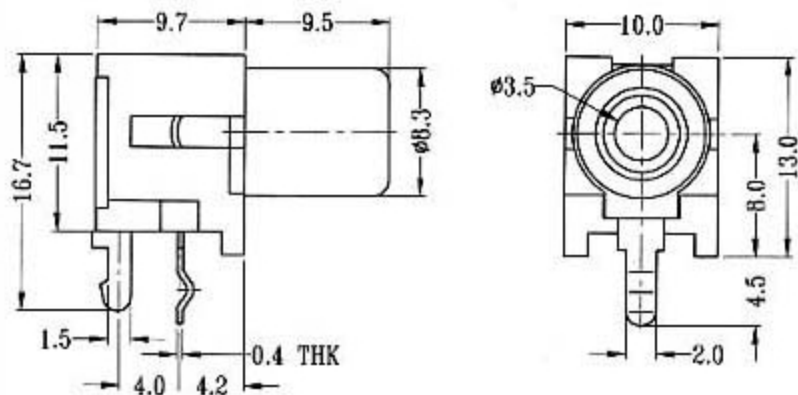

CIRCUIT DIAGRAM

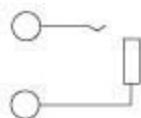

SPECIFICATIONS

Rating : 0.3A 30V DC