

RC-104

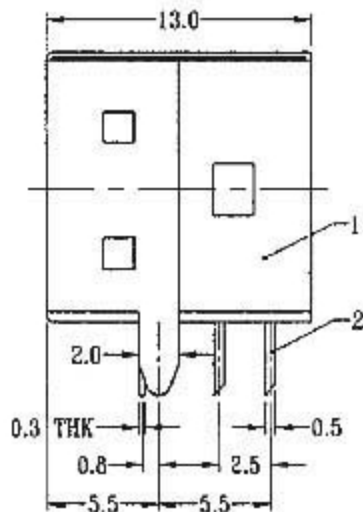

CIRCUIT DIAGRAM

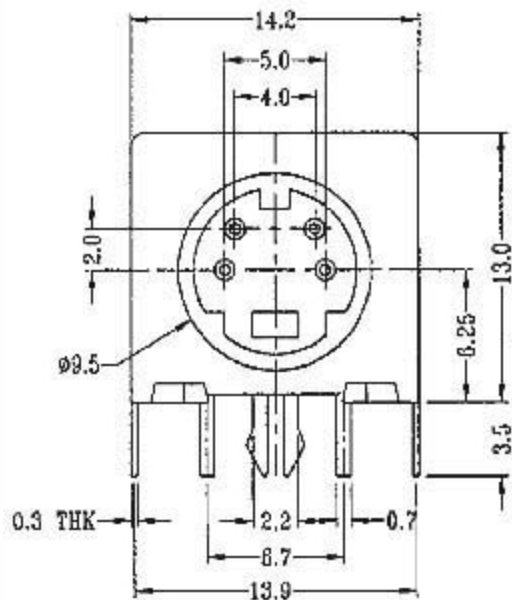
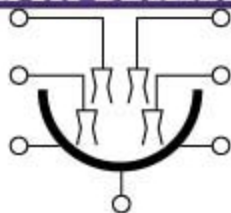

SPECIFICATIONS

Rating : 0.3A 30V DC