

PS-22F98

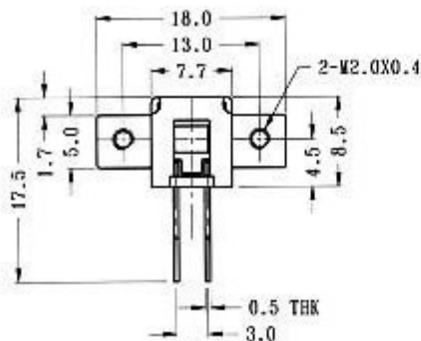

CIRCUIT DIAGRAM

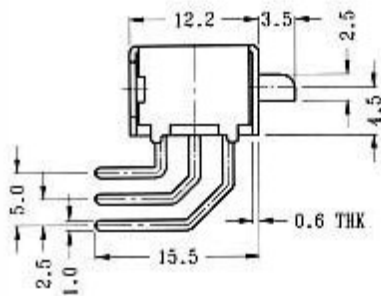
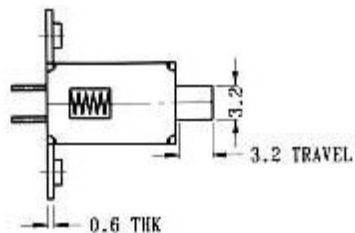
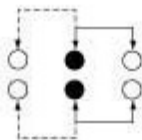

SPECIFICATIONS

N NON-SHORTING

Rating : 0.3A 50V DC
Function: 2P2T