

PS-22F68
PS-22F78

(LOCKED)

(NON-LOCKED)

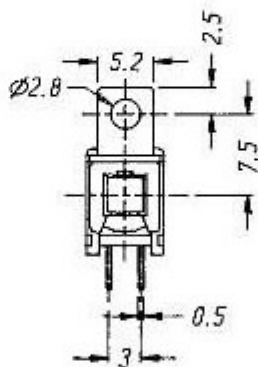
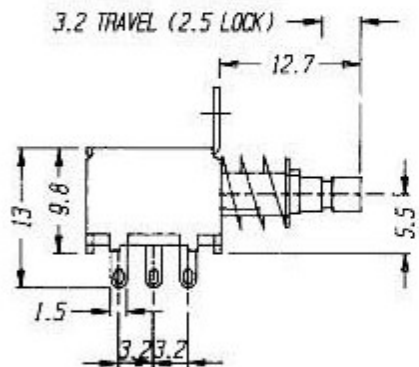

CIRCUIT DIAGRAM

SPECIFICATIONS

N NON-SHORTING

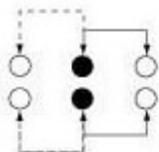

Rating : 0.3A 50V DC

Function: 2P2T