

# PS-22F56

(LOCKED)

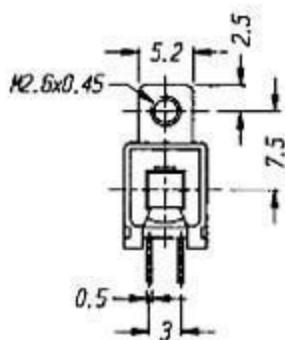

**CIRCUIT DIAGRAM**

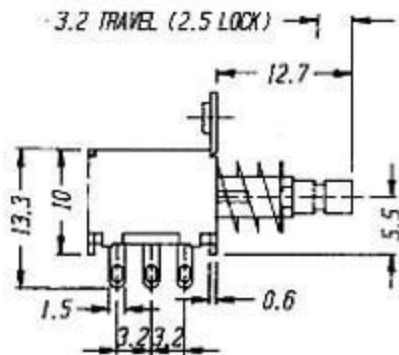
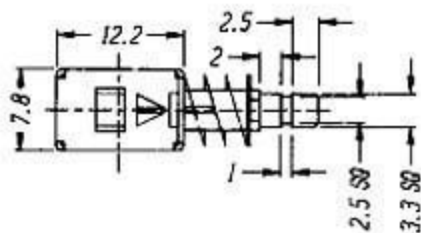
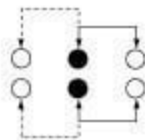

**SPECIFICATIONS**

**N** NON-SHORTING

Rating : 0.3A 50V DC  
Function: 2P2T