

PS-22F52

(LOCKED)

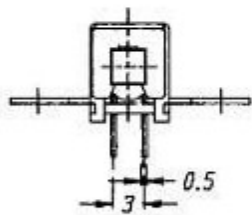

CIRCUIT DIAGRAM

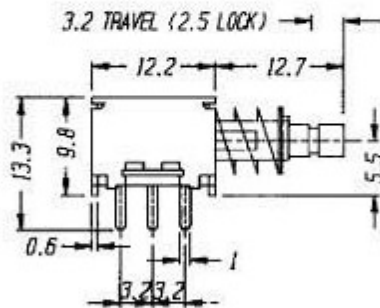
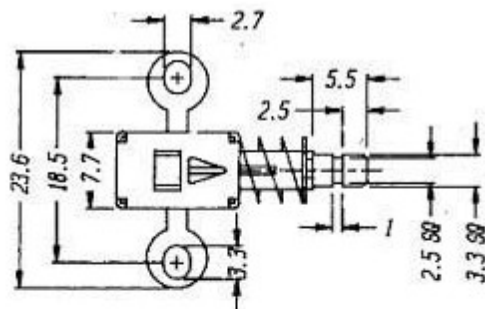
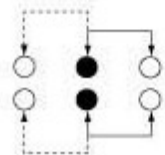

SPECIFICATIONS

Rating : 0.3A 50V DC
Function: 2P2T

N NON-SHORTING