

PS-22F50

(LOCKED)

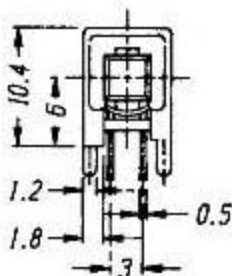

CIRCUIT DIAGRAM

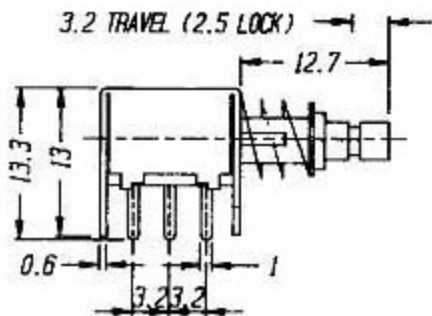
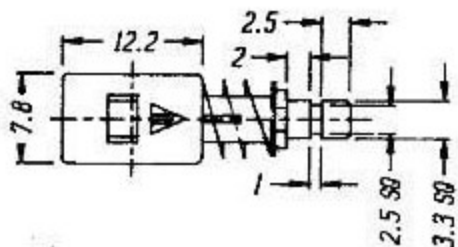
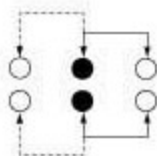

SPECIFICATIONS

N NON-SHORTING

Rating : 0.3A 50V DC

Function: 2P2T