

PS-22F38

(LOCKED)

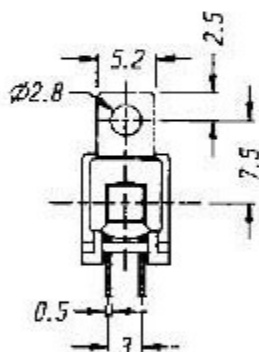
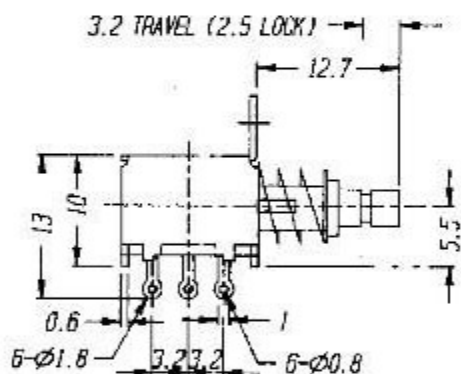
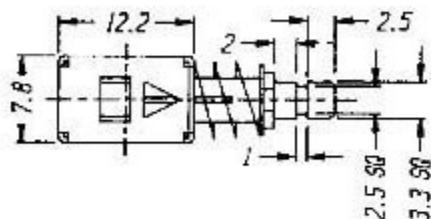

CIRCUIT DIAGRAM

SPECIFICATIONS

N NON-SHORTING

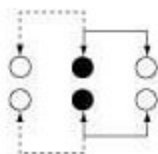

Rating : 0.3A 50V DC

Function: 2P2T