

EX-22H01

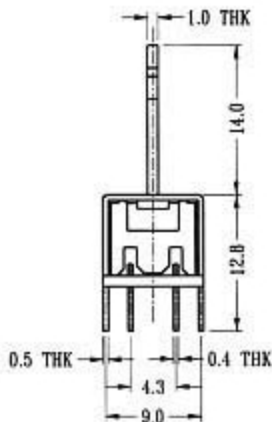

CIRCUIT DIAGRAM

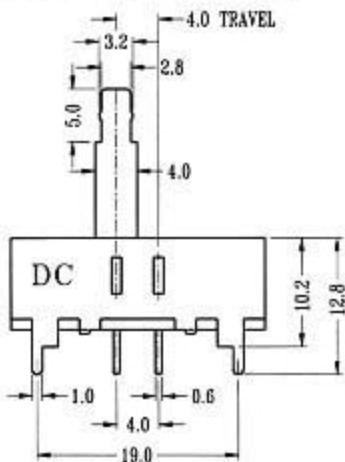
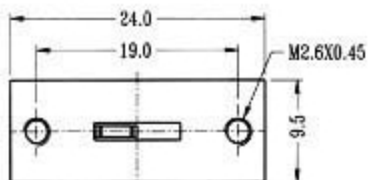
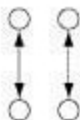

SPECIFICATIONS

Rating : 0.3A 50V DC
Function: 2P2T