

RoHS Compliance

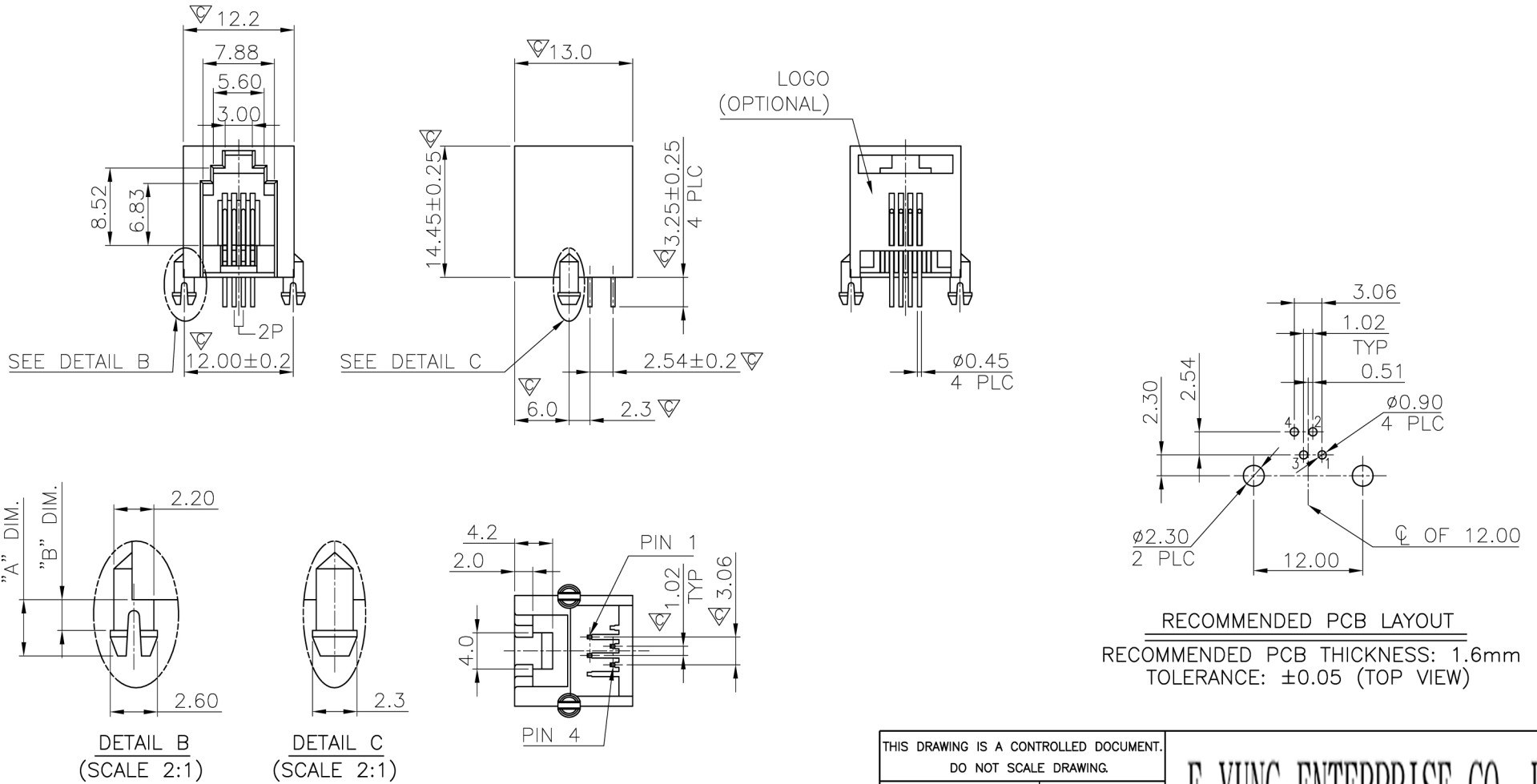

THIS DRAWING IS A CONTROLLED DOCUMENT. DO NOT SCALE DRAWING.	
DIMENSIONS: MM	TOLERANCES UNLESS OTHERWISE SPECIFIED:
 THIRD ANGLE PROJECTION	0 PLC ± -
	1 PLC ± 0.25
	2 PLC ± 0.13
	3 PLC ± 0.05
ANGLES ± -	
MATERIAL SEE NOTES	FINISH SEE NOTES
DWN A.HUANG	DATE AUG-10-2010
CHK M.CHANG	AUG-10-2010
APVD W.J.YANG	AUG-11-2010

E-YUNG ENTERPRISE CO., LTD.		
TITLE 6*4POSITION, MINI LOW PROFILE, SIDE ENTRY PCB JACK		
SIZE A3	CAUGE CODE -	DRAWING NO 961701
WEIGHT -	GRAMS Ref.	REV 8 SHEET 1

LTR	DESCRIPTION	DATE	APVD
REVISIONS			