

10SS6-S-Q

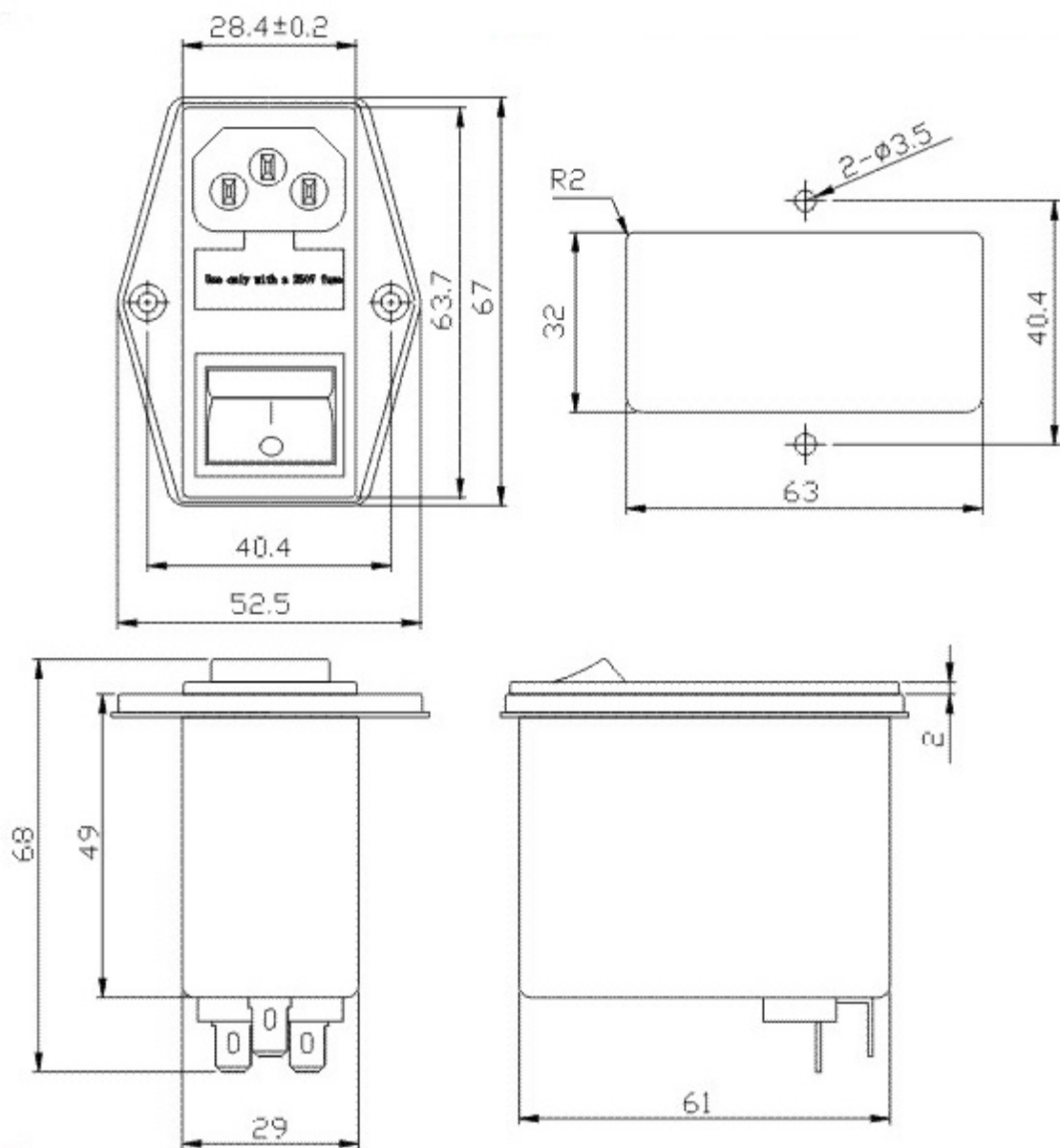

Specifications:

1. Rated Current: 1A , 3A , 6A , 10A
2. Rated Voltage: 115/250 VAC
3. Leakage Current: 0.5mA Max. 250VAC 50Hz
4. Hipot Rating: Line to Ground: 2250 VDC
Line to Line: 1450 VDC
5. Inlet Socket: Compatible With IEC 320
6. Safety Approval:        