

SWITCH TYPE	Micro Switches	MODEL NO.	SM10-05N-**
<b>1. Functional spec.</b>			
1.1 Rated Voltage	125/250VAC	1.6 Free Position	14.0 ± 0.8mm
1.2 Rated Current	10.1A	1.7 Operating Position	12.0 ± 0.8mm
1.3 Contact Resistance	≤ 50mΩ (Initial value)	1.8 Position Travel	≤ 3.6mm
1.4 Operating Force	( ** )gf	1.9 Return Force	
1.5 Bounce Time		1.10	
<b>2. Reliable Rating</b>			
2.1 Mechanical Life	1,000,000 CYCLES	2.5 Soldering Technic	Hand Soldering
2.2 Electrical Life	6,000 CYCLES	2.6 Operating Temper	-25° C - +75° C
2.3 Insulation Resistance	≥ 100MΩ DC500V (Initial value)	2.7 Ambient Humidity Used	< 85%RH
2.4 Withstand Voltage	AC1000V 1 minute (Initial value)	2.8	

**3. Dimension Drawing**

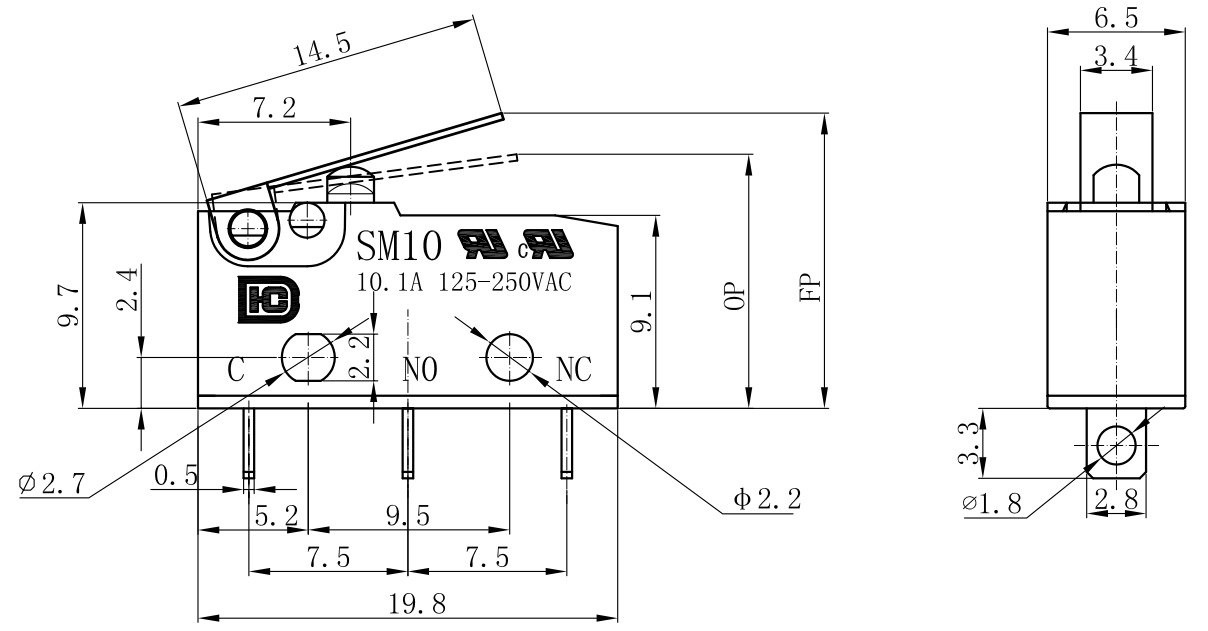

SCHEMATIC

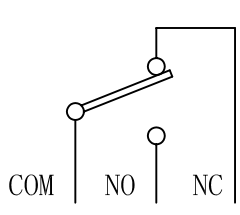

Revision	Description	Date	Revisor
Drawing No.	C/0	Tolerance	± 0.2
Drawing Model.	SPECIFICATION OF STANDARD TYPE	Unit	mm
Prepared	Reviewed	Approved	Effective date