

CUSTOMER DRAWING

REV.	DESCRIPTION	APPL BY	DATE	ECN NO.
B	RELEASE	Fido Wang	12/01/09"	
C	RELEASE TABLE A	Fido Wang	12/01/10"	
D	CHANGE PLASTIC TUBE MATERIAL	Emily Suen	16/05/10"	ECN11030

單箭頭

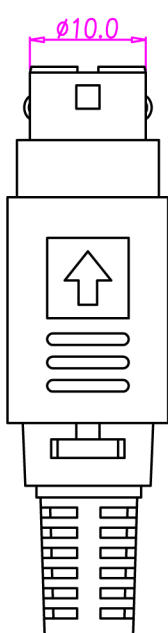
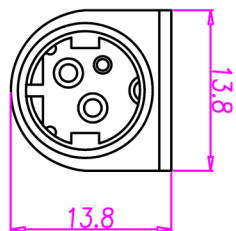

雙箭頭

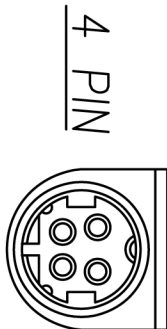
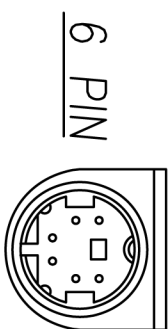
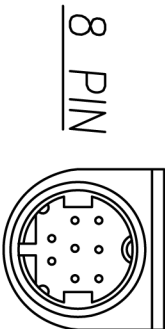
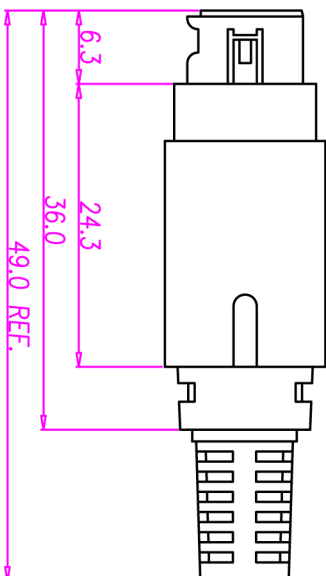
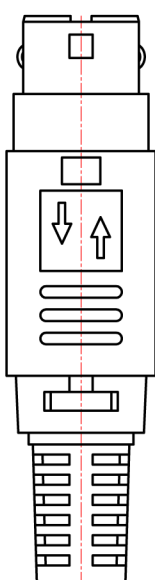
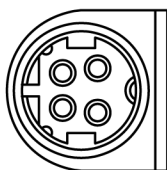

- MATERIAL :
 - 1-1. HOUSING : PBT UL94V-0 ; COLOR : BLACK.
 - 1-2. CONTACT : BRASS.
 - 1-3. PLASTIC COVER : ABS ; COLOR : SEE TABLE A
 - 1-4. PLASTIC TUBE : ABS OR PC ; COLOR : SEE TABLE A
 - 1-5. POM RING : POM ; COLOR : BLACK.
 - 1-6. SR : PVC ; COLOR : SEE TABLE A.
 - 1-7. SPRING : CARBPN STEEL OR STAINLESS STEEL
 - 1-8. METAL CAP : BRASS
 - 1-9. METEL SHELL: BRASS
- FINISH :
 - 2-1. CONTACT : 50 MICRO INCHES MIN. SILVER PLATED
 - 2-4. SPRING : NICKEL PLATED 60u" ~ 100u" OVER ALL.
 - 2-4. METAL CAP : NICKEL PLATED 60u" ~ 100u" OVER ALL.
 - 2-4. METEL SHELL : NICKEL PLATED 60u" ~ 100u" OVER ALL.
- ELETRICAL SPECIGATION :
 - 3-1. RATED CURRENT : 4PIN: 7.5A/DC MAX
3PIN: PIN1 &PIN2 7.5A/DC ; PIN3 1A/DC
 - 3-2. VOLTAGE : 20V/DC MAX
- ENVIRONMENTAL :
 - 4-1. OPERATIONAL TEMPERATURE : -20 C~85C.

DRAW	Ku Chou	APPL	Emily Suen	UNIT	mm	TOLERANCE	* ±0.25 ** ±0.15 *** ±0.10 **** ±0.03 ANGLE ±1°		TITLE	PowerDin 雙箭頭	SHEET	
CHECK	Emily Suen	SCALE	1:1	ANGULA	±1°	PART NO.			SEE TABLE A	DWG NO.	QC0962	

CUSTOMER DRAWING
TABLE A

REV.	DESCRIPTION	APPL BY	DATE	ECN NO.
B	RELEASE	Fdo Wong	12/01/09*	
C	RELEASE TABLE A	Fdo Wong	12/01/10*	
D	CHANGE PLASTIC TUBE MATERIAL	Emily Suen	16/05/10*	ECN11030

3 PIN

PD-03M2-44	Power Din 3(M) 圓筒型塑料	藍SR	BLACK	二件式	中檢機:PC/藍噴
PD-03M2-42	Power Din 3(M) 圓筒型塑料	6.5	BLACK	二件式	藍扣
PD-03M2-41	Power Din 3(M) 圓筒型塑料	6.5	GRAY		
PD-03M2-40	Power Din 3(M) 圓筒型塑料	6.5	BLACK		SR 藍扣
PD-03M2-39	Power Din 3(M) 圓筒型塑料	6.5	BAIGI		
PD-03M2-38	Power Din 3(M) 圓筒型塑料	藍SR	BLACK		
PD-03M2-35	Power Din 3(M) 圓筒型塑料	藍SR	BLACK	二件式	中檢機:PC/藍噴
PD-03M2-34	Power Din 3(M) 圓筒型塑料	藍SR	BLACK	二件式	中檢機:PC
PD-03M2-33	Power Din 3(M) 圓筒型塑料	藍SR	BLACK	二件式	中檢機:PC/SR 黃色
PD-03M2-32	Power Din 3(M) 圓筒型塑料	7.0	BLACK		
PD-03M2-31	Power Din 3(M) 圓筒型塑料	6.5	BLACK		
PD-03M2-30	Power Din 3(M) 圓筒型塑料	4.0	BLACK		管子接口
PD-03M2-28	Power Din 3(M) 圓筒型塑料	6.5	BLACK	二件式	管子接口/中檢機:不噴
PD-03M2-26	Power Din 3(M) 圓筒型塑料	5.5	BLACK		SR 黃色
PD-03M2-25	Power Din 3(M) 圓筒型塑料	4.0	BLACK		
PD-03M2-24	Power Din 3(M) 圓筒型塑料	5.0	BLACK		
PD-03M2-23	Power Din 3(M) 圓筒型塑料	7.0	BLACK	二件式	管子接口
PD-03M2-22	Power Din 3(M) 圓筒型塑料	5.0	BLACK	二件式	
PD-03M2-20	Power Din 3(M) 圓筒型塑料	7.0	BLACK		
PD-03M2-18	Power Din 3(M) 圓筒型塑料	5.5	BLACK		
PD-03M2-17	Power Din 3(M) 圓筒型塑料	5.5	BLACK		
PD-03M2-15	Power Din 3(M) 圓筒型塑料	4.0	BLACK	二件式	
PD-03M2-13	Power Din 3(M) 圓筒型塑料	5.0	BLACK		
PD-03M2-11	Power Din 3(M) 圓筒型塑料	6.5	BAIGI	二件式	
PD-03M2-10	Power Din 3(M) 圓筒型塑料	6.5	BLACK		
PD-03M2-08	Power Din 3(M) 圓筒型塑料	5.5	GRAY	二件式	
PD-03M2-05	Power Din 3(M) 圓筒型塑料	5.5	BLACK		管子接口
PD-03M2-04	Power Din 3(M) 圓筒型塑料	6.5	BLACK	二件式	
PD-03M2-03	Power Din 3(M) 圓筒型塑料	6.5	BLACK	二件式	
PD-03M2-02	Power Din 3(M) 圓筒型塑料	5.0	BLACK	二件式	
PD-03M2-01	Power Din 3(M) 圓筒型塑料	5.5	BLACK	二件式	
P/N	DESCRIPTION	SR OD ØD:	COLOR	MATEL SHELL	NOTE

4 PIN

PD-04M2-39	Power Din 4(M) 圓筒型塑料	藍SR	BLACK		
PD-04M2-36	Power Din 4(M) 圓筒型塑料	4.0	BLACK		
PD-04M2-35	Power Din 4(M) 圓筒型塑料	藍SR	BLACK	二件式	中檢機:PC/藍噴/粉漆
PD-04M2-34	Power Din 4(M) 圓筒型塑料	5.0	BLACK		
PD-04M2-33	Power Din 4(M) 圓筒型塑料	藍SR	BLACK	二件式	中檢機:PC/藍噴
PD-04M2-32	Power Din 4(M) 圓筒型塑料	7.0	BLACK		
PD-04M2-31	Power Din 4(M) 圓筒型塑料	藍SR	BLACK	二件式	中檢機:PC
PD-04M2-30	Power Din 4(M) 圓筒型塑料	藍SR	BLACK	二件式	中檢機:PC
PD-04M2-29	Power Din 4(M) 圓筒型塑料	7.0	BLACK		
PD-04M2-28	Power Din 4(M) 圓筒型塑料	藍SR	BLACK		中檢機:PC
PD-04M2-27	Power Din 4(M) 圓筒型塑料	6.5	BLACK		管子接口
PD-04M2-24	Power Din 4(M) 圓筒型塑料	5.5	BLACK	二件式	
PD-04M2-18	Power Din 4(M) 圓筒型塑料	5.5	BLACK		
PD-04M2-16	Power Din 4(M) 圓筒型塑料	5.5	BLACK		
PD-04M2-15	Power Din 4(M) 圓筒型塑料	4.0	BLACK		
PD-04M2-14	Power Din 4(M) 圓筒型塑料	5.0	BLACK		
PD-04M2-10	Power Din 4(M) 圓筒型塑料	6.5	BLACK		
PD-04M2-04	Power Din 4(M) 圓筒型塑料	6.5	BLACK		
P/N	DESCRIPTION	SR OD ØD:	COLOR	MATEL SHELL	NOTE

6 PIN

PD-06M2-03	Power Din 6(M) 圓筒型塑料	5.0	BLACK	二件式	
PD-06M2-02	Power Din 6(M) 圓筒型塑料	6.5	BLACK	二件式	
PD-06M2-01	Power Din 6(M) 圓筒型塑料	6.5	BLACK	二件式	
P/N	DESCRIPTION	SR OD ØD:	COLOR	MATEL SHELL	NOTE

8 PIN

PD-08M2-04	Power Din 8(M) 圓筒型塑料	5.0	BLACK		
PD-08M2-03	Power Din 8(M) 圓筒型塑料	6.5	BLACK		
PD-08M2-02	Power Din 8(M) 圓筒型塑料	6.5	BLACK	二件式	
PD-08M2-01	Power Din 8(M) 圓筒型塑料	6.5	BLACK		
P/N	DESCRIPTION	SR OD ØD:	COLOR	MATEL SHELL	NOTE

DRAW	Ku Chou	APPL	Emily Suen	UNIT	mm	TOLERANCE	±0.25 ±0.15 ±0.10 ±0.03 ±1"
CHECK	Emily Suen			SCALE	1:1	ANGULA	

	TITLE	PowerDin 圓筒式	DWG NO.	QC0962	SHEET	2
	PART NO.	SEE TABLE A			VERSION	D